

Data Sheet



Article number: 0125059

Description: Retaining ring SP42
Spring steel

Measures

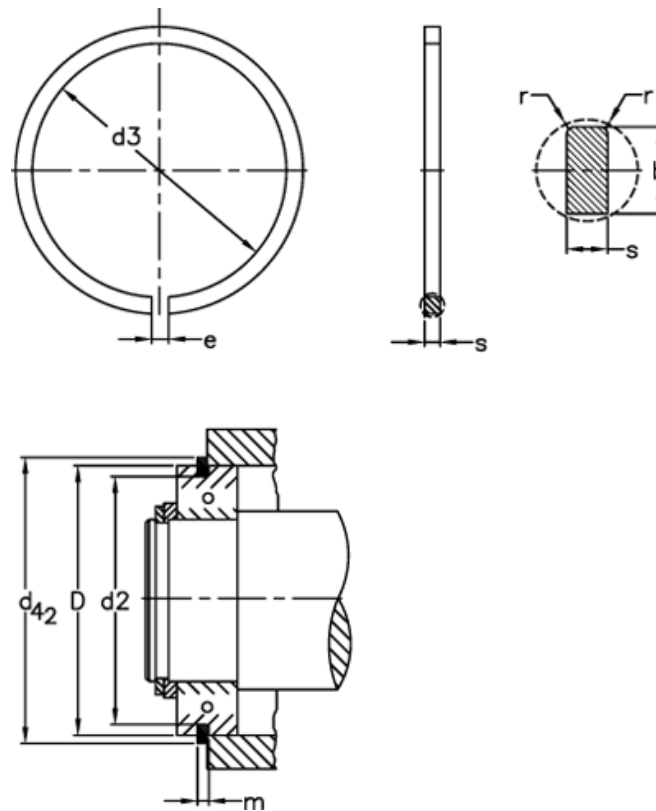

b	= 3.25	FRg kN	= 2.39	tol	= -0.15
D	= 42	FR kN	= 12.9	tol	= -0.1
d2	= 39.75	g	= 2.0	tol	= -0.25
d3	= 38.9	K kN-mm	= 23.4	tol	= 0.3
d42	= 46.3	m	= 1.35	tol	= 0.5
Description	= SP 42	n abl x 1000	= 7.0	Weight kg/1000	= 3.8
e	= 3	r min	= 0.4		
FN kN	= 23.5	s	= 1.12		